

CULINARY Series Model NPC17199S

16 Gauge Undermount S.S. Chef's Sink

"EZ Clean" Zero Radius Corners



SPECIFICATION SHEET

NPC17199S Specification

North Point Industries Inc. Model NPC17199S is a single bowl undermount kitchen sink manufactured from 16 gauge 18/10 antibacterial stainless steel. The entire basin is handcrafted and hand brushed on the bottom and sides. The sink includes our exclusive silent system undercoating and sound deadening pads. The sink includes our deep cup, stainless steel strainer drain, bottom grid, undermount installation clips and template.

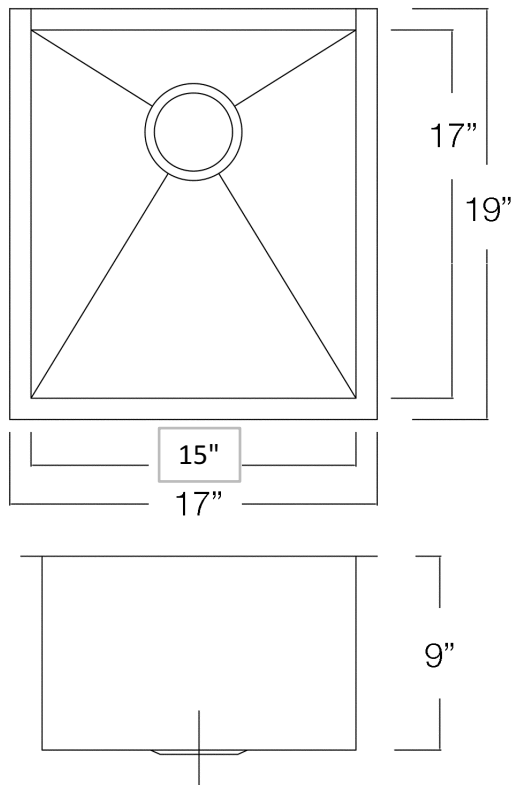

Stainless Steel

Thickness 16 gauge

Type 18/10 Antibacterial

Bowl Configuration

Single Bowl

Install Type

Undermount

Cabinet Size

24" front to back

18" wide

Warranty

Lifetime Limited Warranty

Included Items

Silent System undercoating

Silent System deadening pads

Deep Cup strainer drain

Undermount mounting clips

Bottom Grid

Install template

